



Thunderbird NEWS

DECEMBER 2017 VOLUME 19, #12



PROUD ORGANIZER OF THE ANNUAL TROPICAL PARK CLASSIC CAR SHOW

SPONSOR OF THE FELIPE COS MEMORIAL FLORIDA 300 MILE RALLY

WINNER OF THE PRESTIGIOUS 2016 GOLDEN QUILL AWARD



Happy
Holidays!



HAPPY 60th ANNIVERSARY OF THE 1957 THUNDERBIRD

Thunderbirds at Lakeland . CTCI Membership News
Car Shows and Cruis-Ins . Holiday Gift Guide
New Officers Election



CTCI Classic Thunderbird Club International Membership



It's called the **Classic Thunderbird Club International**, and you will find members throughout the United States and all over the world.

Why a Thunderbird Club?

Classic Thunderbird Club International (CTCI) was formed to band together owners and admirers of the 1955-57 Ford Thunderbird — to serve as a medium of exchange of ideas, technical information, and sources for parts. Lasting friendships have been formed through local chapters, Regional Conventions and International Conventions. Moreover, CTCI is recognized and sanctioned by the Ford Motor Company, which extends cooperation and support.



What Membership Means

Whether your Classic Thunderbird serves as everyday transportation, a relaxing hobby or both, you will find valuable help in your restoration and maintenance problems in the **TECH TIPS** printed in the club publication, the **EarlyBird**. This informative, illustrated periodical is distributed every two months and contains a variety of interesting features. Articles about historical data, members and their cars, news of chapter events and activities, are all profusely illustrated with photos. In addition, the **EarlyBird** offers an advertising service to those wishing to buy, sell, or swap parts or cars. You can review the contents of the current issue on our web site: www.ctci.org.

Tours, meets, road rallies, picnics and other outings designed to encourage group participation are regularly conducted by the various chapter groups. Check our web site www.ctci.org for a chapter near you. You are cordially invited to attend any of these friendly chapter meetings or events. CTCI members may also participate in Concours d'Elegance competition at CTCI conventions.



Standard or Premium Packet

Every new member receives a Standard New Member Packet upon payment of the initiation fee and dues. This includes a striking windshield decal, the latest edition of the **EarlyBird**, a membership roster with our club By-Laws, 3"x5" CTCI logo dash plaque and other general information. The optional Premium Packet includes the above plus a beautiful metal CTCI grille emblem. Many items such as service and transmission manuals, decals, handbooks and numerous self help items are available and sold to CTCI members only. See our Member Store at www.ctci.org.

OUR OBJECTIVE:
EVERY CLASSIC T-BIRD OWNER IS A CTCI MEMBER

CTCI Classic Thunderbird Club

International Membership

I encourage all New Club Members to join CTCI as soon as possible and Current Members to keep your CTCI membership up to date.

Felipe Cos founded our CTCI Chapter, #114 for South Florida in November 1998. Since then our club has hosted a CTCI International Convention in 2004 and grown to include 50 member families.

Look at the benefits of membership. For myself, I have saved a lot of time and money by visiting Gil's Garage, hosted by Gil Baumgartner CTCI Authenticity Chairman and 'Thunderbird Guru' and the Early Bird Club magazine is full of great articles and Club stories!

I have included the current CTCI membership application, which is available www.ctci.org in an editable .pdf format.



Online Renew for 1 year 2018 for \$37.50 or signup for 3 years at \$105.00 (35.00 a year)



Classic Thunderbird Club International

1308 E. 29th Street, Signal Hill, CA 90755-1842 USA • 562.426.2709 • Fax: 562.426.7023 • Email: ctcioffice@ctci.org • Web site: www.ctci.org
Phone Toll Free 1.800.488.2709

MEMBERSHIP APPLICATION

PLEASE TYPE OR PRINT:

Name _____ Spouse's Name _____

Mailing Address _____

City _____ State/Province _____ Zip/Mail Code _____

Telephone (_____) _____ Email Address _____

CTCI Chapter Affiliation (if any) _____

- New members please fill out application and send payment (in U.S. funds ONLY*) to the address above.
- Make checks payable to CTCI, or pay by credit card by email, fax or phone.
- Current members may renew dues online at www.ctci.org.

Please select one of the following prorated amounts:

Month Joining	One Time Initiation Fee +	Dues =	Total
<input type="checkbox"/> January thru March	\$15.00 +	\$35.00 =	\$50.00
<input type="checkbox"/> April thru June	\$15.00 +	\$26.50 =	\$41.50
<input type="checkbox"/> July thru September	\$15.00 +	\$18.00 =	\$33.00
<input type="checkbox"/> October thru December	\$15.00 +	\$9.50 =	\$24.50

NOTE: Add \$16.00 to select Premium Packet with CTCI Grille Emblem.

Annual dues renewal will be \$35.00, payable January 1 of each year.

Premium Packet with Grill Emblem = Add \$16.00 to total

TOTAL ENCLOSED: (\$US) _____
*NOTE: Members **outside the U.S.** may pay dues by credit card. You may send credit card information by email, fax or phone.
U.S., Mexico and Canada: First Class..... Additional \$15.00/year
Other Foreign Countries: A/O Rate..... Additional \$35.00/year (not including Mexico and Canada)

Signature _____ Date _____ Check here if you wish to be listed in the CTCI roster, as of April 1st.

I give permission for my phone number and/or email address to be listed in the CTCI roster.

(NOTE: Phone numbers & email are for office use only, or for the roster if you choose to have it published. Roster addresses may be sold only to T-Bird vendors to be used only for catalog purposes.)

Are you a former member of CTCI? Yes No If Yes, what is your former CTCI membership number? _____

Sponsored or Referred by _____ CTCI # (if known) _____

CAR DATA

This section is optional, but will help us to complete our historical data base registry. Your ownership information will be kept confidential and will be used only for statistical purposes. This data will be found on the fire wall, inside the engine compartment; left hand side by the heater box. Please fill in the number and letters as stamped on the data plate. If you have more than one T-Bird, please copy this form and submit each car's data. How many Thunderbirds do you own? _____ 55's _____ 56's _____ 57's

Year _____ Serial Number _____

For 1955, 1956, and early 1957's: (see example)

Body _____ Color _____ Trim _____ Production Code _____

For late 1957's:

Body _____ Color _____ Trim _____ Date _____ Trans _____ Axle _____

Registered Owner (if other than member) _____

Address _____

License Number _____ State/Province _____ Is your T-Bird primarily Original or Modified?

Color (if not per data plate) _____ Mileage _____ Condition (rate from 1-5, 1 is best) _____

Special Features or Remarks _____



rev 1/2015-WEB

For Office use Only
CTCI # _____ Date: _____
CK # _____ Amt Rec'd: _____



editor's CORNER

DEC. 2017

Hi Thunderbird Club Members,

This issue will cover our Club Election of new Officers. Please read the Meeting Minutes enclosed. I wrote a short story about Thunderbirds at the Lakeland Car shows in October with pictures of the fine Thunderbirds, many of them from Dave Tulowitzky's Trailbirds Club out of Ft Myers. Starting next year, the Thunderbird News will be more focused on covering mostly Club Events with articles of interest to and from our Thunderbird Club membership as they become available. I welcome any story, keeping in mind a deadline of the 3rd Sunday of the month to submit it.

Top priority will go to articles about a Classic Thunderbird of South Florida Events and we welcome any story about a Classic Car Event where Thunderbirds appear. Technical articles are much appreciated, as some of us do get our fingernails dirty and our knuckles bloodied!

Please look at the Presidents message for information about 2 upcoming Club Events The Holiday Party and January Club show at Tropical Park.

We recently had air-conditioning installed in our Thunderbird by Eagle Overhauling, air conditioning specialists and advertisers supporting the Thunderbird News. Carlos and Diego were great to deal with. The facility, in 3 large buildings, is really something to see! We also had some issues solved and a tune-up performed by Paul at Prime Tune. Our Baby Bird never ran so smoothly! Special Thanks to Paul & Kathy!

Please remember to support our advertising partners and don't forget to tell them you saw it in The Thunderbird News!

OLD CARS Weelky 2016 GOLDEN QUILL AWARD for a Collector Car Club Newsletter.



Our monthly News magazine has lots of useful information, including upcoming Car Shows and Cruise-ins, Club contact information and technical articles. From time to time information becomes outdated. If you see an error, please let us know as soon as possible, so we can be corrected in the next issue.

CTCI 2017 Newsletter Competition GOLD AWARD for our October Rally 2016 Edition



Pictures of the Events are also available for viewing on our Club Facebook Page

www.facebook.com/ThunderbirdClubSouthFlorida

and our club Website NEW ADDRESS

www.TbirdFL.com

I surely appreciate the articles that are being contributed to our Thunderbird News by our members. Please keep them coming! Thanks to you all for contributing to this month's edition,

Ed Raabe

Classic Thunderbird Club of South Florida CTCI CHAPTER #114 DECEMBER 2017 VOLUME 19, #12 REGULAR MONTHLY MEETING

Our meetings are held the Third Wednesday of each month at The Trattoria Pampered Chef 7347 Miami Lakes Dr. Miami Lakes FL 33014 Our Host is Gabriel Nash.

CLASSIC THUNDERBIRD CLUB OF SOUTH FLORIDA BOARD OF DIRECTORS OFFICERS

Oscar Castro President 305 467 8196 oscar@mbsenet.com	Shelly Faust Secretary 954 588 1781 sfaust3605@aol.com
Gary Stump 1st Vice President 786 525 5170 grytbird@aol.com	Peter Klein Treasurer 305 376 8578 pcklein@bellsouth.net
Leo Saladino 2nd Vice President 954 456 4887 leolasharue@aol.com	Ed Raabe Past President 954 3838111 ed.raabe@gmail.com

DIRECTORS

George Bishopric 954 761 1438 georgemia@mac.com	Georgina Dominguez 305-000-0000 gmdominguez4017@aol.com
Connie Danluck 305 206 9053 conico@bellsouth.net	Ernie Saladino 954 559 0068 salamoney1317@gmail.com
Norm Gabe 305 895 3453 norm@environmentalcontrol.com	Grace Vazquez 305 979 1065 4ibuickspecial@gmail.com
Ed Brown 954 931 4542 doubleliz@aol.com	INTERNET DIRECTOR
Felix Hernandez 305 613 6775 hrn3120@bellsouth.com	Oscar Castro 305 457 8196 oscar@mbsenet.com
Mike McNeal 954 786 8571 tamcneal37@aol.com	EVENTS & PROMOTIONS
Bob Toney 305 592 9782 jtoney49@aol.com	Daisy Hernandez 305 613 6775 hrn3120@bellsouth.com



4133 Park Ave. Miami FL 33133
Phone: 305-794-2774 E-mail: PClein@bellsouth.net
Editor Ed Raabe: Ed.raabe@gmail.com
George Bishopric -Newsletter proofreading
www.TBirdFL.com
Facebook Page: www.facebook.com/ThunderbirdClubSouthFlorida
CTCI Chapter #114
Felipe Cos Founder

PAST PRESIDENTS

Felipe Cos 1999	Ed Brown 2006-07
Ken Lemming 2000	Connie Danluck 2008
Felix Hernandez 2001	Ed Brown 2009
Norm Gabe 2002	Daisy Hernandez 2010-11
Andre Fournier 2003-4	Peter Klein 2012-13
Connie Danluck 2005	Ed Raabe 2014-15

DECEMBER Auto Trivia

Q: In January 1930, Cadillac debuted it's V16 in a car named for a theatrical version of a 1920's film seen by Harley Earl while designing the body, What's that name?



The answer is on the last page!



Thunderbird News is the official newsletter of the Classic Thunderbird Club of South Florida. Our purpose is to inform our membership about, club meetings, club activities, Classic Car events and articles of interest to Ford Thunderbird owners.

Articles may be reproduced with the permission of the author. The views and opinions expressed in Thunderbird News are those of the named author and do not necessarily reflect the opinions of the Editor, The Board of Directors of the Classic Thunderbird Club of South Florida or those of the membership.

Tech Corner reprinted with permission from CASCO

THUNDERBIRD INFORMATION SUPER HIGHWAY:

Our Club's web page: www.TBirdFL.com

2005 Thunderbird: _____ www.fordautomobiles.com
 Ford racing: _____ www.fordacing.com
 Speedvision: _____ www.speedvision.com
 CTCI's Home Page: _____ www.ctci.org
 Daytona's Turkey run: _____ www.carshows.org
 Metroplex EarlyBirds: _____ www.geocities.com
 Arizona Classic T-Bird Club: _____ classic-thunderbird.org
 Santa Clara Valley T-Birds: _____ www.tbird.org/scvt
 Sierra Nevada Classic T-Bird: _____ www.tbird.org/snctb
 Connecticut Area Classic T-Bird: _____ www.tbirdsofconn.com
 Chicagoland Thunderbirds: _____ www.thunderbirds.org
 Potomac Classic T-bird: _____ www.hydratech.com
 Old Cars _____ www.greatoldcars.com
 Classic T-Bird Club of Chicagoland _____ www.ctcc9.com

NUMBERS TO KEEP

The following are contact numbers and e-mail address you need to have on file:

AACA Ft Lauderdale Region. President Louis Tassi
 954-782-0107 www.ftlauderdaleaaca.com

AACA South Florida Region. President, Ron Mitro
www.aacasouthflorida.club

Auto Appraisal Network: John & Bret Layzell
 305-899-9963 www.autoappraisalnetwork.com/miami

Benefit Car Shows: Oscar Castro
 305-467-8196 www.benefitcarshows.com
oscar@benefitcarshows.com

Gerry Car Show: Gerry Perez
 786 344-4228 email gerrycarshow@bellsouth.com

Magic Mustangs: Frank Alonso
 305 551-6077 Fadatec@aol.com

Muscle Stangs of Miami: Ayanidys Martinez
 305 321-0437

Jumpin' Jack Productions: Jack Corssino
 305-214-2277 www.jumpinjackproductions.com

DB Entertainment Inc.: Dick Barten
 954-563-4000 Bandsouth@bellsouth.net

Cruisin South Florida: Scott the MusicMan
scott@cuisinsouthflorida.com

Ft Lauderdale Mustang Club: Mark Patterson
www.flmustangclub.com

Cobra Joe Productions: Joe Bevelacqua
jbevrs@msn.com

VMCCA Sun Coast Chapter. President David Bobbitt 305
 661-1340 bobbitt@comcast.net

Russ G Events: Russ Gagliano III
russ@russgevents.com

INTERNET PAGE

Have you seen our internet page? We have changed our address www.TBirdFL.com and we have a Facebook page too! Search Classic Thunderbird Club South Florida or www.facebook.com/ThunderbirdClubSouthFLorida

We encourage participation on our Facebook page. Send Posts about everything Thunderbird related and we will enjoy other "car stuff" too.

Like Museum Visits, Car shows and Cruise Ins you attend. And other stuff you think we T-Bird lovers would like. Just keep it as clean as your T-Bird on "Detail Day"!



HAPPY BIRTHDAYS IN DECEMBER

Alexander Bernaldo	Dec 1
Christie Cos	Dec 2
Charles Fritz	Dec 3
John Virginio	Dec 6
Theresa McNeal	Dec 6
Maria Peraza	Dec 8
Kristine Fritz	Dec 9
Raul Dominguez	Dec 19
Cesar Felipe	Dec 28
Angel Luis Morales Jr.	Dec 29
Daisy Hernandez	Dec 29
Chris Miranda	Dec 31

*You're Not Old
 You're a Classic*



HAPPY BIRTHDAY

My apologies, If I have missed your birthday it is because I do not have your information. Please contact me to update your records.



Hello Fellow Members!

The year 2017 is quickly coming to an end and so is my term as president. It's hard to believe that two whole years have passed since I first became president of this wonderful Club!

It has been a privilege and an honor to have served you as President. My time as president has been a wonderful and rewarding experience. I have seen many good things happen during the past year; our club has grown in membership, the number of activities have increased, and the attendance during our monthly meeting as grown so much that we now have the whole inside of the restaurant for our group! I have also seen the computerization of our membership data base and the event registrations, and I have also seen the overhaul and updating of our website, www.TBirdFL.com. However, among all of these awesome things, there is a specific one that I am the most proud to have been a part of, and that is the continuation of our traditional 300 Mile Rally, or as it is now known, The Felipe Cos Memorial 300 Mile Rally!

I am very pleased about the accomplishments that have occurred over the last two years, and I am happy to have been a part of them in some way, although I certainly cannot take credit for them. This belongs to the hard-working, talented and dedicated board members and all of the club members that we have, for without your enthusiasm, participation, and cooperation, none of this would have been possible. I will miss the role I have been able to play, and I hope to be able to continue to contribute, as much as I can.

I would like to congratulate our incoming president, Paul Werner; I know that he will do a great job and that we will all be in good hands going forward. The Classic Thunderbird Club of South Florida is a club that is beyond awesome and it keeps getting better all the time. I know that I speak for all of you when I tell Paul that we will give him our undivided support and work hard to help him so that he can continue to make this club even better. However, Paul will not have to do it all alone; he will be backed up by our newly elected officers and directors. This fine group of individuals know that to be the most effective and productive, they need take on extra work and they need to be present at most of the events and meetings, as that is the only way to accurately represent their fellow members, and knowing all this, they still



volunteered! Congratulations to Vice President Leo Saladino, Treasurer Peter Klein, Secretary Gail Corenblum, our new directors, Felix Hernandez, Daniel Romagnoli, Stuart Corenblum, and Oscar Castro, and our Newsletter Editor, Ed Raabe, who has signed on for another tour of duty. Thank You all!

I hope that 2016 was a good year for everyone, filled with fun and exciting experiences and that you are now ready to take on 2018 and enjoy all the activities that our club will make available to you. We will start the year with our participation in the R-R-R-R (Redlands Riot Road Rally) on January 20th. Those of you that would like to rally, but are unable to participate in a 3-day event, this is your chance! It is only one day and after the awards presentation, we will all dine together! NEXT on deck is our annual show at Tropical Park on Sunday January 24th, I am sure that with everyone's help, our 2018 show will be better than our 2017 show, but not as good as our 2019 show, which will be even better because we just keep on improving every time!

Information on all of our activities are posted on our website www.tbirdfl.com, check in often! Remember, we shortened the name of our website to www.tbirdfl.com in order to make it easier to give the name to others and prospective new members! The old name, www.thunderbirdclubsouthflorida.com, as well as www.tbirdflorida.com, will also work the same, www.tbirdfl.com is just the shortest, but all 3 will work!

Thank you all for being members of the best Classic Thunderbird Club in South Florida!

Remember... Tomorrow is the first page of a 365 page book, together, let's write a good one!

Happy Thundering!
Oscar Castro
President - 2016 - 2017
Classic Thunderbird Club
of South Florida



ANNUAL RATES for advertising in the newsletter	Full page__	\$675.00
	1/2 page__	\$375.00
	1/4 page__	\$250.00
	Card Size__	\$150.00(Non members)
	Card Size__	\$95.00 (Members only)

THE LAKELAND AUTO SHOW LAKE MIRROR CONCOURS

Formally known as the Lake Mirror Classic, new sponsors, Mid Florida Bank, have renamed this Fall event we wait all year long for! For those who don't know there are 2 venues. The Concours d' Elegance, amazing classic cars ringing picturesque Lake Mirror and the Street Show, with over 200 cars and where you will see entire streets dedicated to a single Marque! Imagine a city block of just Shelby Cobras, Corvettes, Avantis, Jaguars, Mustangs, Cougars as well as Hot Rods, Pickups, Muscle Cars, Sports and Exotics! The quality of the cars at the street show is outstanding, many would easily qualify for the Concours event.

The Show was included this year as the destination of the Florida 300 Mile Rally that our club sponsors and the weather could not have been better!

John Layzell, Bob Heslekrants and Michael Arias entered their cars in the Street Show.

At the Concours we visited Dave Tulowitzky with the Trail Birds Thunderbird Club, who had 7 or 8 Club member's cars among the Thunderbirds being shown together a perfect circular setting! Dave said he was surprised and honored that the Event organizers featured the Baby Birds on the Concours show field. Boy, did they look great! Sadly, none of our Club Thunderbirds were represented, but there is always "next year"!



2017 HOLIDAY PARTY



SATURDAY DECEMBER 2, 2017 - 6:00 PM - 9:30 PM

THE HOLIDAY PARTY IS A SUBSIDIZED EVENT
FOR 2017 MEMBERS PAY \$ ZERO \$

INVITED GUESTS ARE WELCOMED, BUT THEY MUST PAY THE REGULAR PRICE OF \$34 PER PERSON PRICE

Holiday Inn Miami West

7707 NW 103rd Street, Hialeah Gardens, FL 33016 . (305) 825-1000

Right off the NW 103 Street Exit on the Palmetto Expressway

(NW 103 Street = West 49 Street Hialeah)

Just a couple of exits South of the Monthly Meeting location at Miami Lakes

2-2-2-1+ Buffet

2 Entrees . 2 Sides . 2 Desserts . 1 Coffee + Wine

MEAN SANTA
GIFT EXCHANGE

\$25
GIFT PER PERSON





Holiday Gift Guide

I thought it would be nice to include a list of retailers who offer gifts for automobile lovers. This is just for information and The Thunderbird News is not sponsored by any of the vendors.



Diecast Scale Models



Diecast Direct Inc. www.DiecastDirect.com



Collectible Diecast
www.collectablediecast.com



Diecast Models Wholesale
www.Diecastmodelswholesale.com

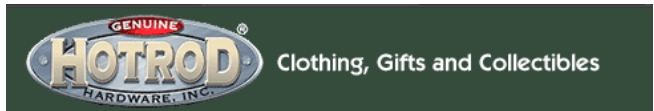

Clothing, Gifts and Collectibles



Hats, Shirts, Neon, Car Care
Gifts Clothing & Collectibles
www.GenuineHotrod.com



Car Covers, Collectables,
Car Care

California Car Cover Co.
www.CalCarCover.com



Classic Thunderbird Club International
www.ctci.org

Thunderbird Manuals,
Brochours, Hats,
Shirts and collectibles

Members Only!



SHOP Old Cars WEEKLY

Great Gift & Stocking Stuffer Ideas!

HOLIDAY GIFT ISSUE

Old Cars

22 Great Gift Ideas
WE SHOP FOR YOU!

GRAND GS
AUTOMOBILE'S NEW 1955 BUICK NIVERA

HOT FUELIE
SUPER RARE FUEL-INJECTED 1959 IMPALTA

SWEET WEEK
MULTIMEDIA CONTENT \$2.50

IOLA '09
Old Cars WEEKLY NEWS & MARKETPLACE

What Is That?
WHY IT'S A BEAST, OF COURSE. IT'S COOL, IT'S ONE OF A KIND, IT'S HAND-BUILT, AND IT'S NEVER BEEN TO A CAR SHOW!

By Bruce Evans

It's a hand-built, one-of-a-kind, one-of-a-kind, one-of-a-kind... It's a hand-built, one-of-a-kind, one-of-a-kind... It's a hand-built, one-of-a-kind, one-of-a-kind...

1930-1984 VALUES IN THIS ISSUE

Old Cars Report Price Guide

Featuring BONUS Old Cars Reports on:

- 1959 Chevy Impala
- 1969 Ford Mustang Boss 302

LARGER, EASIER TO READ TYPE

Market Watch
What will be "hot" in Scottsdale

Values in 1-6 Condition Ratings

1958 Chevy Impala

2017 / 2018

Hemmings CATALOG

MAGAZINES, CALENDARS, CLOTHING, HATS, PUZZLES, MODEL CARS...

Model Cars
1/24 Scale
1/43 Scale
1/64 Scale
1/87 Scale

CALENDARS
12 Months
12 States
12 Cities

CLOTHING
T-Shirts
Hats
Sweatshirts

PUZZLES
1000 Pieces
500 Pieces
250 Pieces

BOOKSHELF

FORD MODELS
DODGE
STUDEBAKER 1946-1958
THE ALL-AMERICAN MUSCLE CAR

MOTOR NEWS
HEMMINGS Racing #1954

2018 CALENDARS • Choose from 7 titles

MODEL A FORD 2018 CALENDAR
THE '60s' CALENDAR
THE '50s' CALENDAR
CCARLES CALENDAR

WORLD'S LARGEST COLLECTOR-CAR MARKETPLACE

Hemmings Motor News

REANINGTON, VERMONT

Summit RACING EQUIPMENT

Gifts, Clothing & Memorabilia

Hot Rod
Summit Motor Hardware's 1st Annual Holiday Gift Guide

Bumper-to-Bumper ATTITUDE!

Over 250 new products!

FREE STANDARD SHIPPING

GenuineHotrod.com 1-800-575-1932

The Complete Book of Classic Ford F-Series Pickups
Ford F-Series pickups have been the world's best selling vehicle for most of the past 40 years, and now you can learn why! Starting with the original F-1 autorick, this book covers every classic model produced from 1948 to 1978. This book also includes 134 color and 148 black and white photos, 200 pages, hardbound, 9 1/2" x 12", ISBN: 978-0-89331-844-7

Laid-Back Bronco T-Shirts
Drop the top and show some love for your Bronco! Available in men's and women's sizes. MCL, US, \$19.97; 2X, \$21.97

Ford F-Series Die-Cut Sign
This 12" aluminum sign has a chrome-plated case and features a 1/4" power cord for the cool blue neon light. Mounted powered by one AA battery (not included). MCL-4076, \$24.97

Ford Trucks Cap
This 100% cotton hat cap delivers hundreds of AA, AAA, and D batteries. Includes a carrying case. Imported. ISBN: 978-0-89331-844-7

Built Ford Tough Hoodie
From the street and strip to the city and the backwoods, the 100% cotton hood cap delivers hundreds of AA, AAA, and D batteries. Includes a carrying case. Imported. ISBN: 978-0-89331-844-7

Ford F-1 Key & Letter Holder
This 12" x 12" key holder measures 7 1/2" W x 7 1/2" H x 3/4" D. It's made from hand-painted cast resin, and sports two hooks on the bumper to hold keys to a hot Ford (not really) of keys. ISBN: 978-0-89331-844-7

Hard-working Ford!
Chromed-out hotrod air truck, but your collector needs a truck willing to go to a hard day's work. This 2 1/4" scale die-cast model of a 1934 Ford 8B 157 ton truck features opening doors and hood, detailed engine and interior, and functional steering and suspension. Turn the crank on the side to operate the rear door. Also includes a hydraulic jack and one 1/2" scale truck tire. ISBN: 978-0-89331-844-7

It's Ford o'clock!
This 12" x 12" wall clock has a double chrome-plated plastic case, precision chrome-plated hands, and a single AA battery (not included). Plus a cool blue neon light and a power cord. Includes a hand-drawn JAC decoder with 100 pages of information. ISBN: 978-0-89331-844-7

Route 66: Make every mile one to remember!

It's cooler on Route 66
No matter how you want it, you'll find it on Route 66. It's cooler on Route 66. It's cooler on Route 66. It's cooler on Route 66.

12 states in 12 hours!
This wall-mounted map features 12 states in 12 hours. It's a 12" x 12" wall-mounted map featuring 12 states in 12 hours. It's a 12" x 12" wall-mounted map featuring 12 states in 12 hours.

Travel Route 66
Looking at pictures and reading stories about Route 66 are great, but what if you wanted to experience the magic of the Mother Road for yourself? This book includes 100 recommendations for places to visit, and stay the night along the road's most memorable spots. It's illustrated with over 170 color and black and white photos of interesting destinations and historic memorabilia. ISBN: 978-0-89331-844-7

The Route 66 Encyclopedia
Curious about Route 66? Look up in this handy encyclopedia. This book contains 225 black and white and 541 color photos from the author's own collection, plus contributions and proceeds from many other Route 66 historians. ISBN: 978-0-89331-844-7

Route 66 Lost & Found: Mother Road Ruins and Relics—The Ultimate Collection
Robert Charles Foster lost 1/4 of a century's worth of Route 66 history. This extraordinary book features over 200 different photographs, maps, sketches, campgrounds, B&B's, truck stops, and more along the route's 2,000 miles. They're depicted from the ground up through photographs and journal postcards, then on the facing page as they appear today, from the exact same angle. The collection features 100 color and 127 black and white photographs, plus 57 maps, 400 pages, softcover, 8 1/2" x 11". ISBN: 978-0-89331-844-7



PARTS FOR SALE



White vinyl convertible top
Aftermarket Non-original frame included
Very good condition, no rips or tears

\$900.00

Contact Leo Saladino
leolashlarue@gmail.com

CLASSIC THUNDERBIRD CLUB OF SOUTH FLORIDA C.T.C.I. CHAPTER #114

Dedicated to the preservation of the Classic Thunderbird

<http://www.thunderbirdclubsouthflorida.com>

Classic Thunderbird Club of South Florida
c/o Peter Klein
4133 Park Ave., Miami FL 33133

MEMBERSHIP YEAR 2018 APPLICATION / RENEWAL

NAME: FIRST _____ LAST _____ DOB month ___ day ___

SPOUSE or S-O's NAME _____ DOB month ___ day ___

ADDRESS _____

CITY _____ ZIP _____ E-MAIL _____

HOME PHONE _____ CELL PHONE _____

WORK PHONE _____ PROFESSION _____

I OWN A 1955_ 1956_ 1957_ OTHER YEAR _____ THUNDERBIRD CTCI MEMBERSHIP # _____ *

*CTCI Membership required for owners of 1955-57 Thunderbirds CTCI Application go to www.CTCI.org

ANY OTHER ANTIQUE CAR OWNED _____ / _____ / _____

PLEASE RETURN THIS FORM WITH YOUR CHECK

NEW MEMBERS: Initiation Fee \$15.00 Plus 1 Years' Membership Fee \$35.00

MEMBERS: 1 Year Renewal \$35.00

Payable To: Classic Thunderbird Club of South Florida

Mail To:
Classic Thunderbird Club SFL
c/o Peter Klein
4133 Park Ave., Miami FL 33133



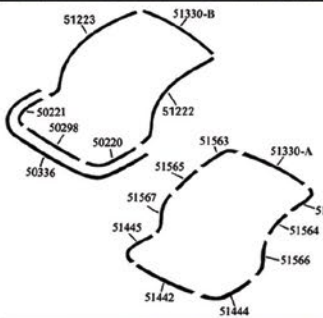

TOP WEATHERSTRIP KITS

We have been told that all of our hardtop & soft top weatherstrips are **"The Best Available"**.

We carry both types of hardtop weatherstrips!

SOFT TOP KIT

51502-CK 10 Pc. Kit. 394.95

HARDTOP KITS

51500-AK 55/Early 56, 7 Pc. Kit. 394.95
 51501-BK Late 56/57, 7 Pc. Kit. 394.95



HEATER CORE

Our **Exact Reproduction** of the original unit that came in your Thunderbird!

NOT A REBUILT UNIT!

18476 55/57 99.95



HOOD AIR SCOOP GRILL

Our gorgeous reproduction for your 55/57 Thunderbird.

This grill kit comes complete with a beautifully chromed grill, four studs, correct clips & nuts.

16607-RK 55/57 72.95



OUR REPRODUCTION

CORRECT RING

COWL MOUNT ANTENNA

We have a high quality reproduction cowl mount antenna for your 1955-57 T-Bird!

This antenna has the correct "ring", **As Original**. It was also made with a **stainless steel** mast, not steel like some cheaper versions.

Our kit includes antenna with plastic base & rubber pad.

18813-AR 55/57 kit 59.95



STAINLESS STEEL

NEW!

SOFT TOP/HARD TOP SIDE RECEPTACLES

Change out your worn receptacles with a brand new, high quality, **stainless steel** ones. They come with a new pin for your top so you have all new parts!

50502-RHSK RH, For hard topea. 64.95
 50503-LHSK LH, For hard topea. 64.95
 50502-RSSK RH, For soft topea. 64.95
 50503-LSSK LH, For soft topea. 64.95



UPHOLSTERY KIT

Upholstery Kit Includes: Seat Covers, Backrest Board, Door Panels, Quarter Panel Cardboards, Windlace, Garnish Rail Covers, Arm Rest Covers, Welt Cord Beading, Vinyl Floor Cover, Dash Cover, Drop Curtain & Carpet **CALL FOR PRICING!**



BALL JOINT KIT

Upper & lower ball joints with original style washers & seals and all attaching parts!

3051-K 55/57, New 194.95



EXHAUST MANIFOLD

We made these excellent reproduction manifolds with **original engineering numbers** in the castings!

The LH Manifold is for Thunderbirds with 272, 292 & 312 Y-Block Engines. The RH can be used on all 272, 292 & 312 Y-Block Engines with dual exhaust.

9430-EDB RH 255.00
 9431-ECJ LH, Thunderbird only 255.00



OIL FILTER ADAPTER KIT

This oil filter adapter kit is used to convert 'can' type filter to a 'spin-on' type.

6882-K 55/57, Adapter 29.95
 6881-K 55/57, Adapter & spin-on filter 37.95



WATER PUMP PULLEY

For your 55/57 Thunderbird. This pulley is made with a 1" smaller diameter. **This helps the water flow faster and cool better.**

8509-SP 55/57 99.95

SHEET METAL

We have a Full Selection of sheet metal available!

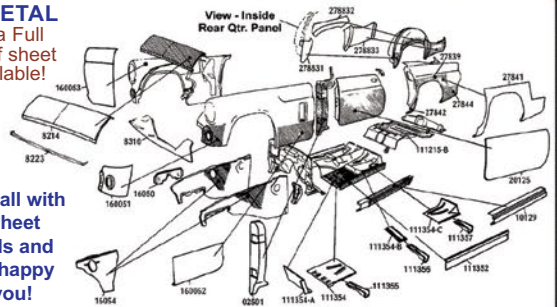

UPCOMING CLASSIC CAR EVENTS

CAR SHOWS

Holiday Car Show
Sunday December 3rd

More

Festival Marketplace | (954) 979-4555 | coupon@festival.com
2900 W Sample Road, Pompano Beach, FL 33073

TOY DRIVE
MIAMI SPRINGS
OPEN CAR & TRUCK SHOW

REGISTRATION \$10.00
+ 1 UNWRAPPED TOY
= \$20 WITHDRAWAL

DJ SCOTT THE MUSIC MAN

SATURDAY DECEMBER 9 / 6 PM - 10 PM

CIRCLE OF MIAMI SPRINGS
1 CURTISS PARKWAY, MIAMI SPRING FL 33166

ALL CLUBS WELCOME

- Top 30 Awards: Best Decorated Vehicles
- Dash Plaques: First 100 Vehicles
- Vendors On Site
- Full Screen TV Raffle
- Gas Card Raffle

A Jumpin Jack Production
www.cruisingouthflorida.com 305-214-2277 (CARS)
www.jumpinjackproductions.com

CHE MILANESA & HAVANA 1928 PRESENTS

FIRST ANNUAL CHRISTMAS CRUISE-IN & TOY DRIVE

DECEMBER 9TH 2017

11735 SW 147TH AVE

BRING ANY UNWRAPPED TOY

TOYS FOR TOTS CAR SHOW 6PM TO 10PM

Festival Marketplace Annual Holiday Car Show
Sunday, December 3, 2017 - 10am to 4pm

The LARGEST Semi-Annual CAR SHOW in South Florida
OVER 600 registered cars last Holiday Show
"Open Show" - Classic, Foreign, Rods etc. all welcome.
Music, Fun, Food and Lots and Lots of GREAT CARS.
GREAT SHOPPING at the Festival's 300 Indoor Air-Conditioned Shops.

Pre-Registration CLOSES Thursday, November 29, 2017
Day of Show Registration OPENS 8am CLOSES NOON.

***FIRST 200 Pre-Registered Cars Receive FREE \$10.00 Gas Card

PLUS All registrants receive:
Free "T" Shirt for the First 600 entries. Free Lanyards & Show ID tag
Free \$10.00 Food Voucher for Festival Food court Free \$20.00 Festival Dollars
Free Coffee, donuts, bagels, muffins for all entrants 8:00am - 10:00am.
Free Hospitality Tent 11:00am - 2:00pm - Free Snacks & Drinks for entrants.

Top 75 Awards Trophies & \$1000 Cash Awards, Individual and Clubs
DJ Scott the Music Man. LIVE Entertainment.
Vendor area...Auto related, Antiques, Collectibles @ \$100.00 per space

Festival Flea Market Mall is located at 2900 W Sample Road at the Florida Turnpike (Exit #69), Pompano Beach, Florida. 954-979-4555

Registration Form - Or Register online with Credit Card at:
<https://festivalmarketmail.eventbrite.com>

Name: _____
Address: _____ City & Zip: _____
Phone or Cell#: _____ E-mail: _____
Vehicle Yr: _____ Make: _____ Model: _____ Club: _____

Please make checks payable to DB Entertainment Inc.
Mail to: PO Box 880742, Boca Raton, FL 33488-0742
Or Register online with Credit Card at: <https://festivalmarketmail.eventbrite.com>

Pre-Registration ONLY \$30.00 per car. \$35.00 Day of Show.
Vehicles admitted after Noon \$20.00 NO PERS!
Car Clubs CONTACT DIKE or JACK for parking arrangements.

Info: Dick Barren 954-563-4000 E-Mail: ben@southfloridacruisers.com
Jumpin' Jack 305-221-0272
Festival: Phone: 954-979-4555 E-Mail: Promotions@festival.com
Show Updates at: <http://festival.com/car-show> www.cruisingouthflorida.com

THIS IS A RAIN OR SHINE EVENT!!!

CRUISERS

DECEMBER 10, 2017

30th ANNUAL TOYS IN THE SUN RUN CAR, TRUCK & BIKE SHOW

SOUTH FLORIDA'S MOST UNIQUE DECEMBER EVENT!!
10 AM - 4 PM MARKHAM PARK, SUNRISE, FL - RAIN OR SHINE

LIVE ENTERTAINMENT BEGINNING AT NOON

BENEFITS JOE DIMAGGIO CHILDREN'S HOSPITAL FOUNDATION
PRE-REGISTRATION \$20 + A NEW UNWRAPPED TOY (UNTIL DEC 3) - DAY OF SHOW \$25 + A NEW UNWRAPPED TOY - BOTH INCLUDE ENTRY FOR 2 (ARRIVING TOGETHER) TO EVENT
DUE TO ALLERGIES NO STUFFED ANIMALS PLEASE
DASH PLAQUES FIRST 100 VEHICLES
LOCAL ROAD CLOSINGS AT 9AM - YOU MUST BE INSIDE MARKHAM PARK NO LATER THAN 9:15AM
55 "BEST OF" AWARDS (15 FOR 2000-2016 VEHICLES)
FOR ADDITIONAL INFORMATION: STEVE 954 806 9000
FORM FOR PRE-REGISTRATION ONLY. MAKE CHECKS PAYABLE TO JOE DIMAGGIO CHILDREN'S HOSPITAL

NAME: _____ PHONE: _____
ADDRESS: _____
CITY: _____ STATE: _____ ZIP: _____
VEHICLE MAKE: _____ MODEL: _____ YEAR: _____
EMAIL: _____
MAIL TO: CRUISERS OF SOUTH FLORIDA, 5099 CLEVELAND STREET, HOLLYWOOD, FL 33021

THE CHILDREN'S HEALING INSTITUTE

CARS & COFFEE PALM BEACH
MONTHLY GATHERING OF SOUTH FLORIDA'S FINEST AUTOMOBILES
8AM-NOON

4th Annual HOLIDAY TOY DRIVE \$5 Per Vehicle To Display in Show Field

1751 Palm Beach Lakes Blvd.
West Palm Beach, FL 33401

duPont REGISTRY

Official 2017 Sponsors:

- McLaren Palm Beach
- Audi West Palm Beach
- REDLINE
- TINT WORLD
- Land Rover Palm Beach
- Land Rover CarLife
- HOB
- Lashway
- STRAPEE
- Independent
- Autohaus
- Custom Wheel Connection

www.carsandcoffeepb.com

Dream Eat Classic Florida's Hollywood

FIRST SUNDAY OF THE MONTH
10:00am - 3:00pm
Hollywood Boulevard
between 19th & 20th Avenue

Classic Cars, Modern Classics & Custom Cars
Free Admission • Vehicle Registration \$20
On-site registration from 8:00am - 10:00am
or pre-register at CobraJoeProductions.com

Information: 954.825.1027
CobraJoeProductions.com

Sponsored by
COBRA JOE PRODUCTIONS
HOLLYWOOD

4 GREAT SOURCES FOR On-Line CAR SHOW INFORMATION

- Benefitcarshows.com
- Flacarshows.com
- Cruisingouthflorida.com
- Southadecarshow.com



UPCOMING CLASSIC CAR EVENTS

CRUISE-INS

CAR CRUISING
FOOD, DRINKS & HOT CARS

CAROLINA ALL HOUSE
FOOD & BEVERAGE

EVERY 1ST SATURDAY
\$3.25 SINGLES • \$5.50 DOUBLES
SMIRNOFF VODKA • CAPTAIN MORGAN'S • JOSE CUERVO • MEYER'S

\$2.50 DRAFTS
BUDWEISER • BUD LIGHT

BLUD LIGHT

CAR CRUISING
FOOD, DRINKS & HOT CARS

CAROLINA ALL HOUSE
FOOD & BEVERAGE

EVERY 3RD SATURDAY
8PM - 10PM
\$3.25 SINGLES • \$5.50 DOUBLES
SMIRNOFF VODKA • CAPTAIN MORGAN'S • JOSE CUERVO • MEYER'S

\$2.50 DRAFTS
BUDWEISER • BUD LIGHT

BLUD LIGHT

8669 NW 36TH ST, DORAL, FL 33166
786-344-4228

2nd Wednesday of Every Month: 6:30pm-9pm
Roll out to some Classic Rock & Roll
D.J. Jammin' Jimmy

For more Information Contact
Car Show Johnny
561-756-3063

CLASSIC and CUSTOM CAR SHOW

Location: Ellie's 50's Diner
2410 North Federal Highway
Delray Beach, FL 33483

WED. - 12 RIBS - 10% OFF FOOD
OPEN TO ALL TYPES & MODELS

Art of Speed, PERFECT STUDIO, DCNT WARRIORS, etc.

Shula BURGER
America's Burger
BEER, WINE, BEEF

CAR & BIKE NIGHT
WED. JUNE 7TH
6PM TO 10PM

12311 S. DIXIE HWY
PINECREST, FL 33156



NEW CRUISE IN DATES FOR TIJUANA TAXI, 1015 S FEDERAL HWY, DEERFIELD BEACH, FLA...SHOW HOURS 11A-3P..FREE!

SATURDAY MAY 13 & 20

SATURDAY JUNE 10 & 17

SATURDAY JULY 15 & 22

FEATURES DJ ROCKIN RICH REDFORD, 15% DISCOUNT TO RIDES IN SHOW FIELD, SHADED PARKING, GOOD FOOT TRAFFIC, GREAT MENU AND FULL BAR, \$25.00 GIFT CARD FOR MANAGERS CHOICE, GREG, MATT OR CHARLIE GREET YOU AT GATE! FREE!!

CALL 954.675.8070 FOR FURTHER INFO

CAR & BIKE SHOW



LAST SATURDAY EACH MONTH

RICO'S HOT DOGS & BURGERS
2400 NW 7 AV. MIAMI 33127
786-953-8271

SHOWTIME 6 TO 8
FREE CARWASH
FREE CARWAX
FREE CAR CARE
FREE CAR WAX
FREE CAR WAX

GatewayClassic Cars

Tampa ~ Orlando ~ Ft Lauderdale

Last Saturday of every month...

Cars & Coffee

9 a.m. to Noon
Complimentary Coffee and Pastries

Worlds Largest Classic & Collector Car Company

NEW LOCATION FOR FRIDAY NIGHT CRUISE!

SPAREZ

BOWLING ALLEY
5325 S UNIVERSITY DRIVE
DAVIE, FL 33328

Timeless Wheels
Cruise-In

Palmetto Bay Village Center
First Friday Every Month
5:30 - 10:00 pm
19001 Old Cutler Road





CLASSIC THUNDERBIRD CLUB OF SOUTH FLORIDA

Wednesday November 15th Pamper Chef Resturant, Miami Lks, FL.

BY ED RAABE

MINUTES OF MEETING

The meeting was called to order at 7:05pm by our President Oscar Castro. Oscar explained we had a lot of material to cover and we would be sticking to the agenda he sent out to the members by email.

First, he mentioned November birthdays for Ed Raabe and Elvis Padron, who were in attendance and Norm Gerstein who was not.

Next, he told everyone after the meeting Dirk De Groen would be giving a recount of his recent participation in the Classic Safari Challenge Rally to those in attendance from the 500 Florida Marathon and Florida 300 Mile Rally

He reviewed the agenda to including The Holiday party, Redlands Rally, Club sponsored show in January and Elections of Officers

Holiday Party Sunday Dec.3rd , 2017

Several Venues were put forward in the email Oscar sent. These were reviewed and Ed Raabe was given the floor to talk about one he had researched that did not make the email. A vote was taken, and the venue approved by a majority show of hands will be The Holiday Inn Miami West, 7707 NW 103rd St, Hialeah Gardens, FL 33016 (right at the Palmetto Exit) near the Airport.

The goal is to have this Party expense covered 100% by the Club!

There will be a Mean Santa exchange minimum gift expense \$25.00 per person, if you want to participate.

Sunday Dec 3rd 6pm to 10pm

Redlands Riot Rally January 20th ,2018

This Rally occurs every year as a "hut for clues" for the correct answers to question on the Rally sheet. Most correct clues identified wins. The Rally covers the Redlands area and ends at the Schnebly Redlands Winery around 5pm. Oscar proposed a club "After the Rally" get together at his new home or at the Winery at a cost of no more than \$10.00 per person. Club members liked the idea and details would be worked out, prior to the date.

Club Show January 28th ,2018

Oscar said All the Arrangements have been made to hold the Club Annual Car show at Holiday Park in the usual area Sunday, January 28, 2018. He reiterated the NEED for VOLUNTEERS to make the show a success as in past years and asked people

to contact him as soon as possible about assignments. He had printed 1000 4x6 Flyers asking everyone to take some at the end of the night, to pass out at upcoming car shows in their area.

Election of Officers for 2018

Oscar began this part of the meeting by reminding everyone that should you become a candidate for one of the open positions that you should be willing to do whatever it takes to do what needs to be done. The positions open for election were President, Secretary and 3 Directors. Felix Hernandez wanted to remain as a Director while all the existing directors declined the position. Paul Werner was given the floor and stated frankly that he was interested in the Presidency, but he need to be sure that things like the Club Car Show, Auction Brunch, etc. would have a director in charge. Oscar assured him that he would be able, as an incoming Director to get that done. He went on to say again anyone accepting the position should be willing to complete a job that is started by a Director if the need arises. Ed Raabe requested the floor. Ed thanked Oscar for his great work as President speaking of his many achievements including updated our Membership file and creating a way for new members and current members to get and renew their membership on line through the Website. Bringing that Website into the 21st Century, growing our Club membership exponentially and creating some of the best Club Events ever. Ed also said that Paul would make a great President, since he has a great love for the Club, the Thunderbird Car and experience as President of several professional organizations in his field of Dentistry. He assured Paul that he would have the support of the Club Directors and membership is he accepts. Paul told the group he has very good experience as a delegator and would be interested in the position. Ed Raabe nominated him.

Oscar asked if anyone else was interested in running. There was no response and Paul was elected without opposition, by a unanimous show of hands. Oscar announced Leo Saladino would remain as VP, Peter Klein would remain as Treasurer and the Secretary's position was open if there was someone interested. Ed Raabe and Gail Corenblum volunteered then Ed withdrew. Gail was elected. Directors would be Felix Hernandez, Stuart Corenblum, Daniel Romagnoli and Oscar Castro (Events and Webpage). New Officers and Directors will start their 1 year term in January 2018.

With that done at 7:58pm Stuart Corenblum made a motion to adjourn, it was seconded by Ed Raabe



**We Fix it Right
the First Time
and Guarantee
it for LIFE!**

Brany Binker

**ALL WORK RESTORED
TO SHOWROOM
CONDITION!**

From
Minor Dents
To Complete
Collision
Repair

Body & Paint Work
from People
You Know and Trust



FREE ESTIMATES

Two locations to serve you better:

Original Location
3051 SW 38th Court
Miami, FL 33146
305-448-4100

New West Kendall Location
12539 SW 128th Street
Miami, FL 33186
(Near Tamiami Airport)
305-251-5133



Dedicated to Excellence

**Restoration Parts
& Accessories**

- ★ Great Prices!
- ★ Huge Inventory!
- ★ Experienced Parts Specialists!
- ★ Fast Shipping!

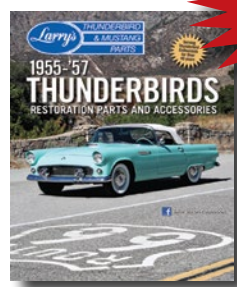

**Order your
FREE
Catalog!**



**Call Today!
(800) 854-0393**

Larry's Thunderbird & Mustang Parts • 1180 California Ave. #B • Corona, CA 92881
Find us On The Web At: www.larrystbird.com



HAVE YOU REGISTERED YOUR CLASSIC THUNDERBIRD?

The purpose of this Thunderbird registry is to find and document as many of these fine cars as possible. All information is welcome, even if the car has been totaled, parted out, or sold to a new owner.

To this date I have registered over 17,000 Classic Thunderbirds worldwide.

To register your Thunderbird, please send the VIN and all other codes from

the data plate on your Thunderbird to:

David Tulowitzky

14191 Tudball Ave.

Port Charlotte, FL 33953

Ph. 941-764-0312

or email: tulobird@aol.com



2017-2018 AACA NATIONAL/REGION EVENTS

(check *Antique Automobile* or www.aaca.org for more information)



November 18, 2017 St. Augustine, FL. Ancient City Region. 33rd Annual Auto Show. Donna Sherrod 904-501-0061; donnabeard88249@icloud.com

2018

February 8-10, 2018- AACA Annual Meeting - Philadelphia, Pennsylvania

March 2-3, 2018- AACA Special Winter Meet/Special Annual Grand National -CANCELED San Juan, Puerto Rico

April 5-7, 2018 -Southeastern Spring Meet – Hornets Nest Region Charlotte, North Carolina

April 20-21, 2018- AACA Western Spring Meet – Tucson Region - Tucson, Arizona

May 31-June 2, 2018 -Annual Grand National Meet- Greensburg, Pennsylvania

July 11-14, 2018- Eastern Spring Meet– Gettysburg, Pennsylvania

August 20-24, 2018-Reliability Tour– Geneva, New York



THE CLASSIC THUNDERBIRD CLUB
OF SOUTH FLORIDA
PROUDLY INVITES YOU TO OUR



SUNDAY JANUARY 28, 2018

10:00 AM - 3:00 PM

GATES OPEN AT 9:00 AM
TROPICAL PARK MAIN ENTRANCE
7900 SW 40th STREET
MIAMI, FL 33155

15 TROPHY CLASSES & BEST OF SHOW
PLUS BEST CLUB & LONGEST DRIVE

LIVE DJ & FOOD VENDORS
BRING THE FAMILY!

www.TBirdFL.com

DETAILS & DISCOUNTED ON LINE REGISTRATION
TELEPHONE REGISTRATION
305-467-8196



GATE REGISTRATIONS ACCEPTED ON A SPACE AVAILABLE BASIS



PROUD PRINTER OF THIS NEWSLETTER



Minuteman Press of Doral

Follow us
minutemanpress_doral

2818 NW 79th Ave
DORAL FL, 33122
ph. (305) 477-2817
miami@minutemanpress.com
www.doralprinting.com

10% DISCOUNT DURING MAY FOR THUNDERBIRD MEMBERS



EAGLE OVERHAULING, INC

Serving since 1976
500 WEST 27th Street
Hialeah, Florida 33010

MVP94100566
Auto
Air Conditioning
Parts
Rebuilding
Compressors
Evaporators
And Driers
Faaca Distributors

Carlos A. Acosta
Productions Manager
(305) 887-7349
Fax: (305) 884-7762



Classic Thunderbird Club of South Florida

3140 S. Ocean Dr. FL 33009
Tel/Fax (954) 456-4887
E-mail: leolashlarue@aol.com
www.thunderbirdclub.us

Leo Saladino
Vice-President
Cell: (718) 812-0991

Peter Klein
First Vice President, Wealth Management
Financial Advisor
Portfolio Manager

Wealth Management
220 Alhambra Circle, 10th Fl
Coral Gables, FL 33134

tel 305 460 7825
fax 305 448 5738
toll free 800 637 4394

Morgan Stanley

www.fa.smithbarney.com/peter_klein
peter.klein@morganstanley.com



Thunderbird Specialists
CASCO
SINCE 1969

**REPRODUCING & MANUFACTURING PARTS FOR
1955-1957 THUNDERBIRDS SINCE 1969**

Most orders shipped same day! Call for a free catalog

CLASSIC AUTO SUPPLY
795 HIGH STREET, COSHOCTON, OH 43812
orders 800-374-0914 . tech help 740-622-9700
www.classictbird.com



PRIMETUNE **ACDelco**
Complete Auto Repair

2620 NE 5th Avenue • Pompano Beach, FL 33064
Call Paul at (954) 785-7779

- Comp. Reprogramming & Reflashing
- Computer Diagnostics
- Starter/Alternator/ Batteries
- Radiators/ Cooling Systems
- Major/ Minor Engine Repair
- Air Conditioning
- Brakes
- Front end work
- Carburetors
- Hi-Performance Work

www.primetuneauto.com



TRATTORIA PAMPERED CHEF
Classic Italian Cuisine

"Very Good" MIAMI HERALD
"A SOLID HIT" TRAVEL HOLIDAY,
GOOD VALUE DINING GUIDE
Catering • Parties • All Occasions
GABRIAL NASH

7347 MIAMI LAKES DRIVE
MIAMI LAKES, FL 33014

TEL.: (305) 825-8919
CELL.: (786) 210-3539
FAX: (305) 825-8918

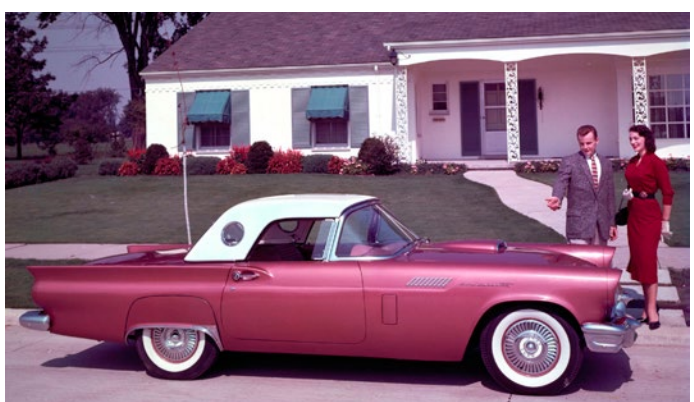



BULLSEYE
www.bullseyepowdercoating.com



POWDER COATING



CERAMIC COATING



SANDBLASTING

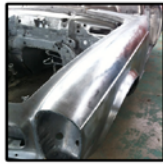

CAR STRIPPING



305-278-2111
info@bullseyepowdercoating.com

Toll free order line 866-949-1956
Tech Support 740-949-2217
www.hillsresto.com



*Check out our website for Cars for Sale and Restorations in Progress
*Full & Partial Restorations Available
*Classic, Antique, & Muscle

**Your first choice in: 1955-1957 Thunderbird
Sheet Metal; Used & NOS Parts**

"We have everything you need...to make your vision come true!"

Drive Through Time with Peace of Mind

Proud to Support the Classic Thunderbird Club of South Florida

J.C. Taylor
Antique Automobile Insurance Agency
1-888-ANTIQUE (1-888-268-4783)
www.jctaylor.com

©2013 2015

Thunderbird Headquarters

COMPLETE 1955-1969 THUNDERBIRD PARTS WAREHOUSE



(800) 227-2174
(925) 825-9550
parts@tbirdhq.com
www.tbirdhq.com

WWW.TBIRDHQ.COM



OCT. / NOV. Auto Trivia

Q: In January 1930, Cadillac debuted it's V16 in a car named for a theatrical version of a 1920's film seen by Harley Earl while designing the body, What's that name?



A: The "Madam X", a custom coach designed by Earl and built by Fleetwood. The sedan featured a retractable landau top above the rear seat.

CTCI NEWS

DUES ARE DUE in NOVEMBER each year
\$35.00 MEMBERSHIP ARE DUE By **DEC. 1st**,
To become a member or renew your membership,
please go online to
www.TBirdFL.com
Checks may be sent to:



THE CLASSIC THUNDERBIRD CLUB OF SOUTH FLORIDA

Attention: Peter Klein, Treasurer
4133 Park Ave. Miami FL 33133

Early Bird owners, Don't forget your CTCI membership
See the membership information in this issue and in Early Bird
magazine, November-December edition.

SECOND EDITION RELEASED

Felipe Cos introduced
The Second Edition of the
"Thunderpedia of the Classic
Thunderbird" at the Branson/
Springfield Convention.
It has over 300 questions and
answers, 1,000 photos, and over
150 pages, all related in how to
fix our Classic Thunderbirds.
There are no other books
similar to this.

Price is \$35.00 Postage is \$6.00

For more information contact
Ed Raabe by email at
ed.raabe@gmail.com

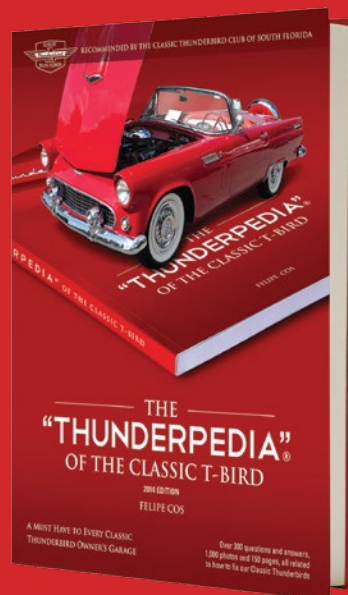

To all members

Remember that this newsletter
goes to press the 15th of each
month. Please remember the
date!

If you want your article to appear,
I need it by the 15th!

We welcome any contributions
that members can make to our
newsletter!

This year We want to feature
stories about YOUR 1955
Thunderbird.

Do you have any interesting
photos of your car? Send it to me!
Do you have any interesting story
about your car? Send them to me!





NPD[®]

NATIONAL PARTS DEPOT

Restoration/Performance
Parts & Accessories since 1976

Make your dream happen.

**3 LOCATIONS
NATIONWIDE**

**HUGE IN-STOCK
INVENTORIES**

**24/7 PHONE
SUPPORT**

**FREE SHIPPING
ORDERS OVER \$300
UPS GROUND ORDERS ONLY**

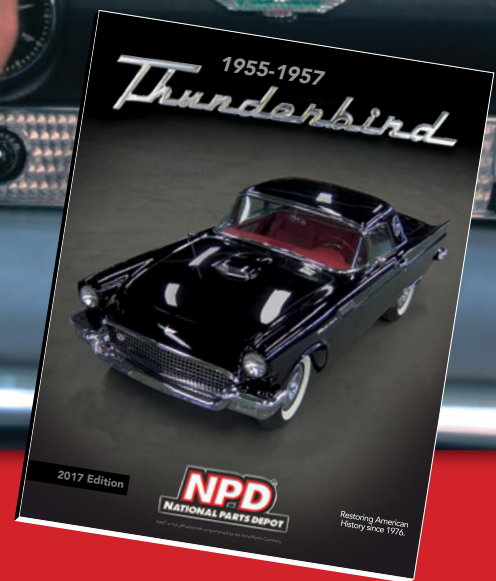

CALL NOW!
FREE Parts Catalogs
800-874-7595



VISIT US AT
WWW.NATIONALPARTSDEPOT.COM

**3 LOCATIONS
WALK IN HOURS**
Mon. - Fri. 8am-7pm
Sat. - Sun. 9am-5pm

FLORIDA DEPOT
800-874-7595
900 SW 38th Ave
Ocala, FL 34474

MICHIGAN DEPOT
800-521-6104
2435 S Haggerty Rd
Canton, MI 48188

N CAROLINA DEPOT
800-368-6451
7000 MacFarlane Blvd
Charlotte, NC 28262

Copyright © 2018 by National Parts Depot, All Rights Reserved



Thunderbird
news